



Flex Pro Transmitter

Radio Control Equipment Instruction Manual



Part Number: 198-50003 R10
April 2019

©Copyright 2019 Magnetek Material Handling

Page Intentionally Left Blank

Table of Contents

1	Introduction	7
2	Radio and Safety	8
2.1	Critical Installation Considerations	9
2.2	General	9
2.3	Persons Authorized to Operate Radio Controlled Cranes	9
2.4	Safety Information and Recommended Training for Radio Controlled Equipment Operators	10
2.5	Transmitter Unit	11
2.6	Pre-Operation Test	11
2.7	Handling Batteries	11
2.8	Optional Rechargeable Battery Charging	12
2.9	Battery Disposal	12
2.10	Crane/Lifting Device Specific Warnings	12
2.11	Specific System Warnings	13
3	General System Information	14
3.1	External Illustration (Pro 12 Configuration)	14
3.2	Internal Illustration (Pro 12 Configuration)	15
3.3	Types of Buttons	16
3.4	Adjustable Speed Control (if equipped)	16
4	Function Settings	17
4.1	System Channel Settings	17
4.2	Inactivity Time-Out Timer	19
4.3	I-CHIP	19
5	Operating Procedure	20
5.1	General Operating Procedure	20
5.2	Changing Transmitter Batteries	21
5.3	Status Lights Indicators and Warnings	22
5.4	Push Button Error Table	23
5.5	Troubleshooting Tips	24
6	Declaration of Conformity	25

Page Intentionally Left Blank

SERVICE CONTACT INFORMATION

Your New Radio Remote Control System

Thank you for your purchase of Magnetek's Enrange™ Flex Pro radio remote control system. Without a doubt, our Flex Pro system is the ultimate solution for providing precise, undeterred, and safe control of your material.

If your product ever needs modification or service, please contact one of our representatives at the following locations:

U.S. Service Information

For questions regarding service or technical information, contact:

1-866-MAG-SERV
(1-866-624-7378)

International Service

262-783-3500

World Headquarters:

Magnetek, Inc.
N49 W13650 Campbell Drive
Menomonee Falls, WI 53051

Telephone: 800-288-8178
Website: www.magnetek.com
E-mail: mhcustomerservice@magnetek.com

Fax Numbers:

Main: 800-298-3503
Sales: 262-783-3510
Service: 262-783-3508

Canada Service Information:

161 Orenda Road
Unit 1
Brampton, Ontario
L6W 1W3 Canada
Phone: 800-792-7253
Fax: 905-828-5707
416-424-7617 (24/7 Service pager)

EU Market Contact:

Brian Preston
Magnetek (UK) Ltd.
Unit 3 Bedford Business Centre
Mile Road
Bedford, MK42 9TW UK
Phone: +44-1234-349191

© 2019 MAGNETEK

All rights reserved. This notice applies to all copyrighted materials included with this product, including, but not limited to, this manual and software embodied within the product. This manual is intended for the sole use of the person(s) to whom it was provided, and any unauthorized distribution of the manual or dispersal of its contents is strictly forbidden. This manual may not be reproduced in whole or in part by any means whatsoever without the expressed written permission of MAGNETEK.

PREFACE AND SAFETY

Product Safety Information

Magnetek, Inc. (Magnetek) offers a broad range of radio remote control products, control products and adjustable frequency drives, and industrial braking systems for overhead material handling applications. This manual has been prepared by Magnetek to provide information and recommendations for the installation, use, operation and service of Magnetek's material handling products and systems (Magnetek Products). Anyone who uses, operates, maintains, services, installs or owns Magnetek Products should know, understand and follow the instructions and safety recommendations in this manual for Magnetek Products.

The recommendations in this manual do not take precedence over any of the following requirements relating to cranes, hoists and lifting devices:

- Instructions, manuals, and safety warnings of the manufacturers of the equipment where the radio system is used,
- Plant safety rules and procedures of the employers and the owners of facilities where the Magnetek Products are being used,
- Regulations issued by the Occupational Health and Safety Administration (OSHA),
- Applicable local, state or federal codes, ordinances, standards and requirements, or
- Safety standards and practices for the overhead material handling industry.

This manual does not include or address the specific instructions and safety warnings of these manufacturers or any of the other requirements listed above. It is the responsibility of the owners, users and operators of the Magnetek Products to know, understand and follow all of these requirements. It is the responsibility of the employer to make its employees aware of all of the above listed requirements and to make certain that all operators are properly trained. **No one should use Magnetek Products prior to becoming familiar with and being trained in these requirements and the instructions and safety recommendations for this manual.**

Product Warranty Information

Magnetek, hereafter referred to as Company, assumes no responsibility for improper programming of a device (such as a drive or radio) by untrained personnel. A device should only be programmed by a trained technician who has read and understands the contents of the relevant manual(s). Improper programming of a device can lead to unexpected, undesirable, or unsafe operation or performance of the device. This may result in damage to equipment or personal injury. Company shall not be liable for economic loss, property damage, or other consequential damages or physical injury sustained by the purchaser or by any third party as a result of such programming. Company neither assumes nor authorizes any other person to assume for Company any other liability in connection with the sale or use of this product.

WARRANTY INFORMATION

FOR INFORMATION ON MAGNETEK'S PRODUCT WARRANTIES BY PRODUCT TYPE, PLEASE VISIT WWW.MAGNETEK.COM.

1 Introduction

The **Flex** radio remote control systems are designed for control of industrial equipment and mobile machinery such as overhead traveling cranes, construction equipment, forestry equipment, mining equipment, rail equipment, drilling and trenching equipment, agriculture equipment, electric hoists, winches, monorails, conveyor belts, mining equipment and other material handling equipment where wireless control is preferred.

Each **Flex** system consists of a transmitter handset and standard-equipped accessories such as a transmitter waist belt, spare transmitter power key, clear vinyl pouch, “AA” alkaline batteries, compass direction decal sheet and user’s manual.

Notable features include:

- **32 user-programmable channels** – Advanced synthesized RF controls with 32 built-in channels; there are no fixed channel and fragile quartz crystals to break.
- **Over 1 million unique ID codes (20-bit)** – Each and every Flex system has its own unique ID code; no repeats.
- **Advanced controls** – The Flex system uses advanced microprocessor controls with 16-bit CRC, which provides ultra-fast, safe, precise, and error-free encoding and decoding.
- **Unique I-CHIP design** – The I-CHIP functions in a way that is very similar to SIM cards used on mobile phones, with the ability to transfer system information and settings from one transmitter to another without the hassle of resetting the spares.
- **Reliable push buttons** – The in-house designed push buttons are rated for more than 1 million press cycles.
- **Low power consumption** – Requires only two “AA” alkaline batteries for more than 100 hours of operating time between replacements.
- **Ultra-durable nylon and fiberglass composite enclosures** – Highly resistant to breakage and deformation even in the most abusive environments.
- **Full compliance** – All systems are fully compliant with the FCC Part-15 Rules, European Directives (Safety, EMC, RED, and Machinery), and Industry Canada Specifications (IC).

2 Radio and Safety

WARNINGS and CAUTIONS

Throughout this document WARNING and CAUTION statements have been deliberately placed to highlight items critical to the protection of personnel and equipment.



WARNING indicates a potentially hazardous situation which, if not avoided, could result in death or serious injury.



CAUTION indicates a potentially hazardous situation which, if not avoided, could result in minor or moderate injury. It may also be used to alert against unsafe practices.

***NOTE:** A NOTE statement is used to notify people of installation, operation, programming, or maintenance information that is important, but not hazard-related.*

WARNINGS and CAUTIONS SHOULD NEVER BE DISREGARDED.

The safety rules in this section are not intended to replace any rules or regulations of any applicable local, state, or federal governing organizations. Always follow your local lockout and tagout procedure when maintaining any radio equipment. The following information is intended to be used in conjunction with other rules or regulations already in existence. It is important to read all of the safety information contained in this section before installing or operating the Radio Control System.

2.1 Critical Installation Considerations



Prior to installation and operation of this equipment, read and develop an understanding of the contents of this manual and the operation manual of the equipment or device to which this equipment will be interfaced. Failure to follow this warning could result in serious injury or death and damage to equipment.

All equipment must have a mainline contactor installed and all tracked cranes, hoists, lifting devices and similar equipment must have a brake installed. Failure to follow this warning could result in serious injury or death and damage to equipment.

An audible and/or visual warning means must be provided on all remote controlled equipment as required by code, regulation, or industry standard. These audible and/or visual warning devices must meet all governmental requirements. Failure to follow this warning could result in serious injury or death and damage to equipment.

Follow your local lockout tagout procedure before maintaining any remote controlled equipment. Always remove all electrical power from the crane, hoist, lifting device or similar equipment before attempting any installation procedures. De-energize and tagout all sources of electrical power before touch-testing any equipment. Failure to follow this warning could result in serious injury or death and damage to equipment.

The direct outputs of this product are not designed to interface directly to two state safety critical maintained functions, i.e., magnets, vacuum lifts, pumps, emergency equipment, etc. A mechanically locking intermediate relay system with separate power considerations must be provided. Failure to follow this warning could result in serious injury or death or damage to equipment.

2.2 General

Radio controlled material handling equipment operates in several directions. Cranes, hoists, lifting devices and other material handling equipment can be large and can operate at high speeds. The equipment is often operated in areas where people are working in close proximity to the material handling equipment.

The operator must exercise extreme caution at all times. Workers must constantly be alert to avoid accidents. The following recommendations have been included to indicate how careful and thoughtful actions may prevent injuries, prevent damage to equipment, or even save a life.

2.3 Persons Authorized to Operate Radio Controlled Cranes

Only properly trained persons designated by management should be permitted to operate radio controlled equipment.

Radio controlled cranes, hoists, lifting devices and other material handling equipment should not be operated by any person who cannot read or understand signs, notices and operating instructions that pertain to the equipment.

Radio controlled equipment should not be operated by any person with insufficient eyesight or hearing or by any person who may be suffering from a disorder or illness that may cause them to lose control of the equipment, is taking any medication that may cause loss of equipment control, or is under the influence of alcohol or drugs.

2.4 Safety Information and Recommended Training for Radio Controlled Equipment Operators

Anyone being trained to operate radio controlled equipment should possess as a minimum the following knowledge and skills before using the radio controlled equipment.

The operator should:

- have knowledge of hazards pertaining to equipment operation
- have knowledge of safety rules for radio controlled equipment
- have the ability to judge distance of moving objects
- know how to properly test prior to operation
- be trained in the safe operation of the radio transmitter as it pertains to the equipment being operated
- have knowledge of the use of equipment warning lights and alarms
- have knowledge of the proper storage space for a radio control transmitter when not in use
- be trained in transferring a radio control transmitter to another person
- be trained how and when to report unsafe or unusual operating conditions
- test the transmitter emergency stop and all warning devices prior to operation; testing should be done on each shift, without a load
- be thoroughly trained and knowledgeable in proper and safe operation of the equipment that utilizes the radio control
- know how to keep the operator and other people clear of hazardous areas
- know and follow the local lockout and tagout procedures when servicing radio controlled equipment
- know and follow all applicable operating and maintenance manuals, safety procedures, regulatory requirements, and industry standards and codes

The operator shall not:

- operate the equipment if the direction of travel or function engaged does not agree with what is indicated on the controller
- operate any damaged or malfunctioning equipment
- change any settings or controls without authorization and proper training
- remove or obscure any warning or safety labels or tags
- leave power on the radio controlled equipment when the equipment is not in operation
- operate any equipment using a damaged controller because the unit may be unsafe
- operate manual motions with other than manual power
- operate radio controlled equipment when low battery indicator is on



The operator should not attempt to repair any radio controller. If any product performance or safety concerns are observed, the equipment should immediately be taken out of service and be reported to the supervisor. Damaged and inoperable radio controller equipment should be returned to Magnetek for evaluation and repair. Failure to follow this warning could result in serious injury or death and damage to equipment.

2.5 Transmitter Unit

Transmitter switches should never be mechanically blocked on or off. When the unit is not in use, the operator should turn the transmitter off. A secure storage space should be provided for the transmitter unit, and the transmitter unit should always be placed there when not in use. This precaution will help prevent unauthorized people from operating the material handling equipment.

Spare transmitters should be stored in a secure storage space and only removed from the storage space after the current transmitter in use has been turned off, taken out of the service area and secured.

2.6 Pre-Operation Test

At the start of each work shift, or when a new operator takes control of the equipment, operators should do, as a minimum, the following steps before making lifts with any equipment:

Test all warning devices.

Test all functions.

Test the transmitter machine stop.

2.7 Handling Batteries



Know and follow proper battery handling, charging and disposal procedures. Improper battery procedures can cause batteries to explode or do other serious damage. Failure to follow this warning could result in serious injury or death and damage to equipment.

Use only batteries approved by Magnetek for the specific product.

Do not dispose of a battery pack in fire; it may explode.

Do not attempt to open the battery pack.

Do not short-circuit the battery.

Keep the battery pack environment cool (for example, not in direct sunlight or close to a heating source) during storage.

2.8 Optional Rechargeable Battery Charging

For those transmitters equipped with rechargeable batteries and battery chargers, all users shall be familiar with the instructions of the charger before attempting to use.

Do not attempt to charge non-rechargeable battery packs in the charger.

Avoid charging partially discharged rechargeable batteries to help prolong battery cycle life.

Do not charge batteries in a hazardous environment.

Keep the battery pack environment cool (for example, not in direct sunlight or close to a heating source) during charging.

Do not short the charger.

Do not attempt to charge a damaged battery.

Use only Magnetek-approved chargers for the appropriate battery pack.

Do not attempt to use a battery that is leaking, swollen or corroded.

Charger units are not intended for outdoor use. Only use charger units indoors.

2.9 Battery Disposal

Before disposing of batteries, consult local and governmental regulatory requirements for proper disposal procedure.

2.10 Crane/Lifting Device Specific Warnings



All equipment must have a mainline contactor installed and all tracked cranes, hoists, lifting devices and similar equipment must have a brake installed. Failure to follow this warning could result in serious injury or death and damage to equipment.

An audible and/or visual warning means must be provided on all remote controlled equipment as required by code, regulation, or industry standard. These audible and/or visual warning devices must meet all governmental requirements. Failure to follow this warning could result in serious injury or death and damage to equipment.

The direct outputs of this product are not designed to interface directly to two state safety critical maintained functions, i.e., magnets, vacuum lifts, pumps, emergency equipment, etc. A mechanically locking intermediate relay system with separate power considerations must be provided. Failure to follow this warning could result in serious injury or death or damage to equipment.

Cranes, hoists, lifting devices and other material handling equipment can be large and can operate at high speeds.

The operator should:

- continuously watch and monitor status of lifted loads
- know and follow cable and hook inspection procedures

The operator shall not:

- lift or move more than the rated load
- use the crane, hoist or lifting device to lift, support or transport people
- lift or carry any loads over people
- operate the crane, hoist or lifting device unless all persons, including the operator, are and remain clear of the supported load and any potential pinch points
- operate a crane, hoist or lifting device when the device is not centered over the load
- operate a crane, hoist or lifting device if the chain or wire rope is not seated properly in the sprockets, drum or sheave
- leave any load unattended while lifted

2.11 Specific System Warnings

The following specific operating safety tips should be strictly followed when operating a Flex Pro system:

- Check the Status LED on the transmitter for any signs of low battery power (**See Section 5.3 Status Lights Indicators and Warnings on page 22**).
- Check the Status LED on the transmitter for any signs of irregularities (**See Section 5.3 Status Lights Indicators and Warnings on page 22**).
- Make sure the system is not set to the same channel as any other Flex systems in use within a distance of 300 meters (900 feet).
- Never operate equipment with two transmitter handsets at the same time unless they are programmed for such use.

3 General System Information

3.1 External Illustration (Pro 12 Configuration)

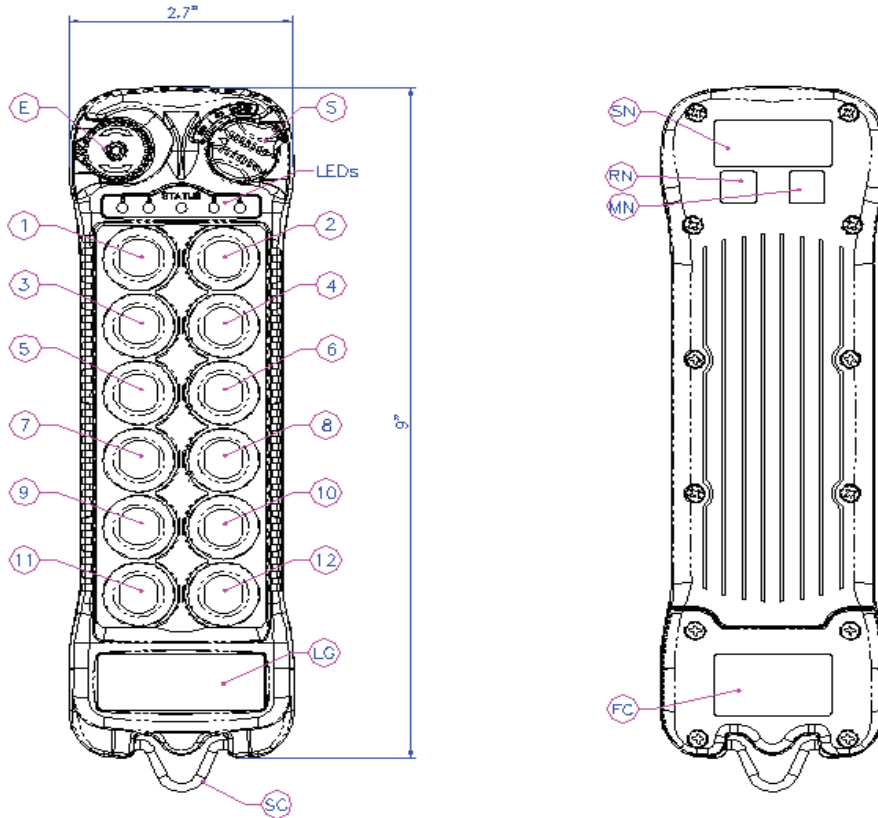

Fig. 1

- | | | | |
|----|----------------------------|-----|--------------------|
| E. | Emergency STOP Button | 9. | Pushbutton #9 |
| S. | Removable Power Key Switch | 10. | Pushbutton #10 |
| 1. | Pushbutton #1 | 11. | Pushbutton #11 |
| 2. | Pushbutton #2 | 12. | Pushbutton #12 |
| 3. | Pushbutton #3 | SC. | Strap Ring |
| 4. | Pushbutton #4 | SN. | System Information |
| 5. | Pushbutton #5 | RN. | System Channel |
| 6. | Pushbutton #6 | MN. | Crane Number |
| 7. | Pushbutton #7 | FC. | FCC Information |
| 8. | Pushbutton #8 | | |

NOTE: Push Buttons #9 – #12 are not present on the Flex Pro 8 Module.

3.2 Internal Illustration (Pro 12 Configuration)

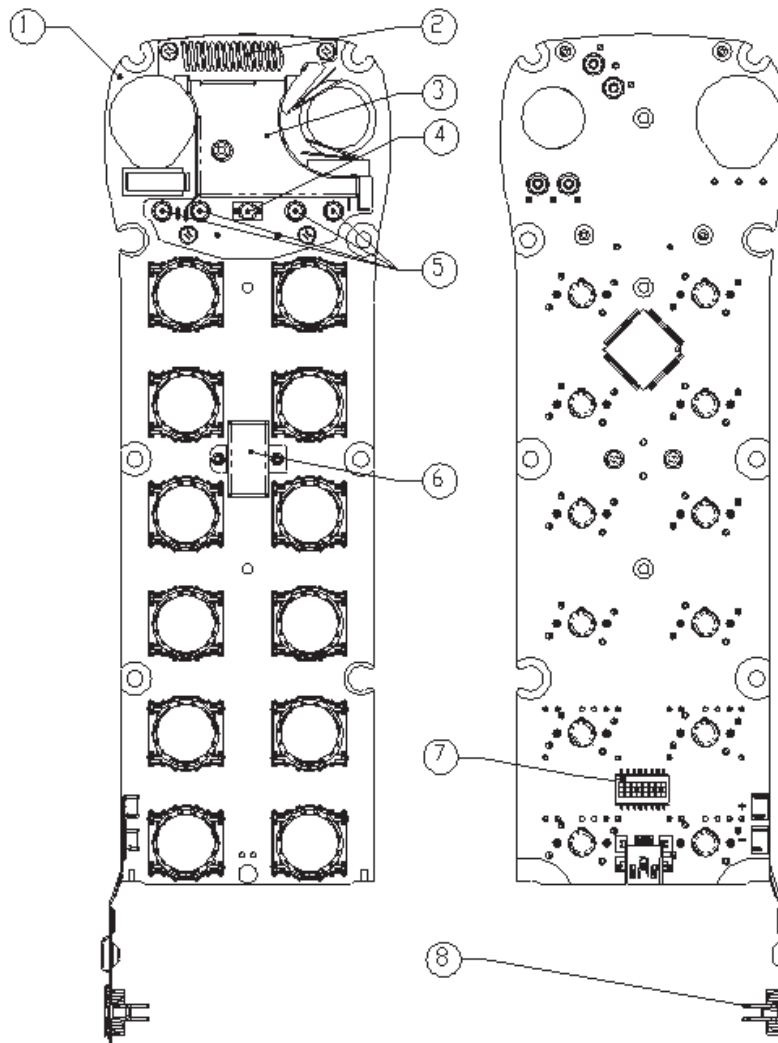

Fig. 2

- | | | | |
|----|---------------------|----|---------------------------|
| 1. | Encoder Board | 5. | Function LED Displays |
| 2. | Aerial Antenna | 6. | I-CHIP |
| 3. | Transmitting Module | 7. | Dip-Switch |
| 4. | Status LED Display | 8. | Battery Contact Mechanism |

NOTE: Flex Pro 8 Module will differ slightly.

3.3 Types of Buttons

The buttons used on the Flex Pro are fully proportional, stepless push buttons with an output that varies 0 – 100%, based on how far the button is depressed. It is possible to model the stepless buttons as an ON/OFF momentary switch, an ON/OFF latched switch, a 2-Speed button, or a 3-Speed button. This modeling is done on the receiver end of the system. Please consult the factory for more information.

3.4 Adjustable Speed Control (if equipped)

The proportional buttons normally operate on a scale from 0-100%, but they can also be scaled down to operate linearly from 0-75%, 0-50%, or 0-25% over the full motion of the button. This gives the user more control over lower speeds. To adjust the speed control settings, press and hold the START button and then press push button 1 or push button 2 to decrement or increment the range percentage. The red LEDs, which indicate the Speed Setting, will then change to reflect the current setting.

Start +	Speed Control Setting
PB1	Decrement Speed Control
PB2	Increment Speed Control



Fig. 3

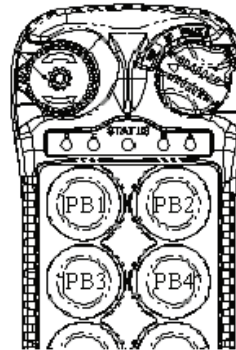

Fig. 4

4 Function Settings

4.1 System Channel Settings

Set the transmitter channel by adjusting the channel dip-switch located on the backside of the transmitter encoder board (refer to Fig. 5). Only the first 5 positions of the dip-switch are used for channel programming (refer to Fig. 6). The system channels table (Table 1 on page 18) describes which dip-switch setting corresponds to which channel. Once the transmitter channel has been altered, set up the receiver to recognize the transmitters on its new channel.

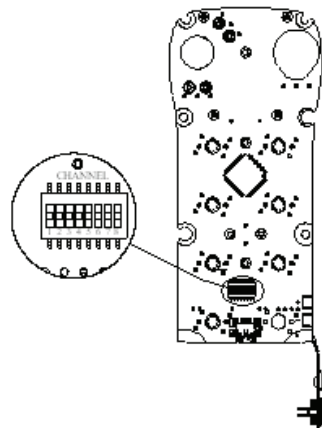

Fig. 5

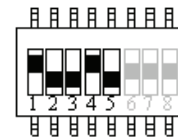

Fig. 6

The dip-switch setting “1 0 0 1 0” shown in Fig. 6 corresponds to channel 19 in the system channels table (Table 1 on page 18).

Table 1: System Channel Table

Channel	Frequency	Dip-switch Setting	Channel	Frequency	Dip-switch Setting
01	433.000 MHZ	00000	17*^	433.800 MHZ	10000
02*^	433.050 MHZ	00001	18*^	433.850 MHZ	10001
03*^	433.100 MHZ	00010	19*^	433.900 MHZ	10010
04*^	433.150 MHZ	00011	20*^	433.950 MHZ	10011
05*^	433.200 MHZ	00100	21*^	434.000 MHZ	10100
06*^	433.250 MHZ	00101	22*^	434.050 MHZ	10101
07*^	433.300 MHZ	00110	23*^	434.100 MHZ	10110
08*^	433.350 MHZ	00111	24*^	434.150 MHZ	10111
09*^	433.400 MHZ	01000	25*^	434.200 MHZ	11000
10*^	433.450 MHZ	01001	26*^	434.250 MHZ	11001
11*^	433.500 MHZ	01010	27*^	434.300 MHZ	11010
12*^	433.550 MHZ	01011	28*^	434.350 MHZ	11011
13*^	433.600 MHZ	01100	29*^	434.400 MHZ	11100
14*^	433.650 MHZ	01101	30*^	434.450 MHZ	11101
15*^	433.700 MHZ	01110	31*	434.500 MHZ	11110
16*^	433.750 MHZ	01111	32*	434.550 MHZ	11111

NOTE: Frequencies marked with * are approved for use in Australia.

NOTE: Frequencies marked with ^ are approved for use in Singapore.

4.2 Inactivity Time-Out Timer

Bits 6 and 7 on the dip-switch allow the user to define a time after which, if no buttons on the transmitter are pressed, the Flex Pro will send an OFF command to the receiver and power down. To restart the unit, the user must turn the ON/OFF/START switch to the OFF position and then back to ON again to resume operation.

Time Out	Dip-switch Setting
5 minutes	01
10 minutes	10
15 minutes	11
Never shut off	00

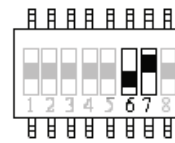

Fig. 7

4.3 I-CHIP

The I-CHIP functions in a way that is very similar to a SIM card inside a mobile phone, which stores system information such as your telephone number, account number, phone book and other settings. The I-CHIP works exactly the same way, as it stores information such as system access code and CAN source address.

When replacing a transmitter handset, take the I-CHIP out of the old transmitter and install it into the new one (refer to Fig. 8).

For safety purposes, the system access code stored inside the I-CHIP cannot be changed directly on the transmitter encoder board. You can change transmitter access code via an external I-CHIP programmer or duplicator unit available from the factory. Please ask your local dealer for assistance if your system requires access code adjustments.

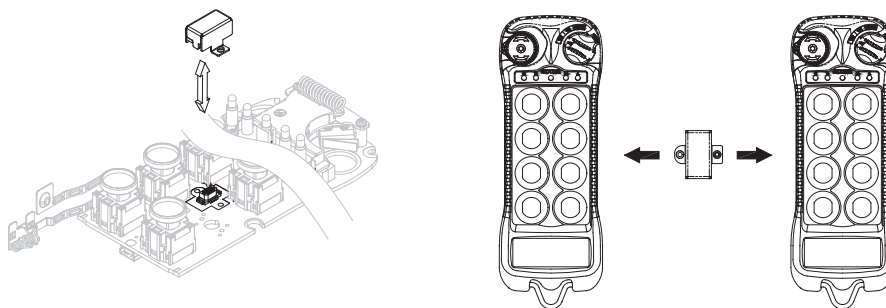

Fig. 8



When opening and closing the unit, take special care to ensure the arms of the microswitch for the OFF/ON/START switch are not damaged when the printed circuit board is put back into the top housing. Ensure that the OFF/ON/START switch is in the OFF position before putting the board in the top housing.

5 Operating Procedure

5.1 General Operating Procedure

1. Reset the red emergency stop button located on the top left hand side of the transmitter handset by turning it either clockwise or counterclockwise. The red button will pop up.

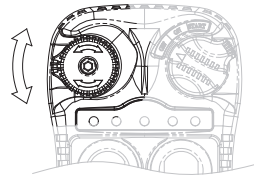

Fig. 9

2. Turn on the transmitter power by inserting the black-colored key into the power key slot located on the top right hand side of the transmitter handset, and turn it clockwise to the ON position.

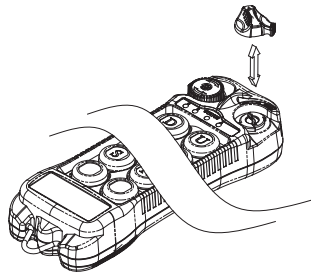

Fig. 10

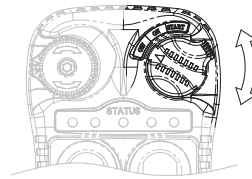

Fig. 11

3. After turning on the transmitter power, check the Status LED on the transmitter handset for any sign of system irregularities (**See Section 5.3 Status Lights Indicators and Warnings on page 22**). If the system is normal, the Status LED will light up green for 2 seconds and then slowly flash green.
4. If there are no signs of any system irregularities, turn the power key further clockwise to the START position for up to 2 seconds. This will activate the receiver E-Stop. Thereafter, the same START position will become an auxiliary function with momentary contact.



Fig. 12

5. Press any push button on the transmitter handset to operate the equipment. When a button is pressed, the Status LED will flash orange with a variable speed dependent on how far the button is pressed. The further a button is pressed, the faster the LED will flash. When no buttons are pressed, the Status LED will slowly flash green.
6. In case of an emergency, pressing down on the red emergency stop button will immediately disconnect the receiver E-Stop and turn off the unit. To reset the emergency stop button, turn the red button either clockwise or counterclockwise and then cycle power to the unit.
7. After a period of inactivity (push button not pressed) defined by the dip-switch, the receiver E-Stop will be disconnected and the unit must be power cycled before being turned on again.
8. Turn off the transmitter power by turning the power key counterclockwise to the OFF position. The Status LED will display a solid red for 4 seconds. This will disconnect the transmitter power and the receiver E-Stop altogether. Turn it further counterclockwise to release the key.

5.2 Changing Transmitter Batteries

Change the transmitter batteries by unscrewing the battery cover located on the backside of the transmitter (refer to Fig. 13 and Fig. 14). During battery installation, make sure that the ribbon is centered between the two batteries. After changing the batteries, also make sure that all screws are tightened to avoid water, moisture, dirt, grease, or other liquid penetration.

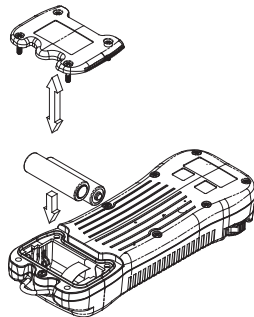

Fig. 13

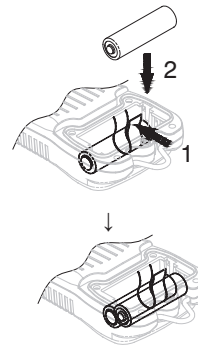

Fig. 14



WARNING

The combined voltage of the batteries cannot exceed 3.0V.

5.3 Status Lights Indicators and Warnings

Type	Display Type	Indication
1	Slow green flash (Normal operation)	Transmitter on and in standby.
2	Flashing orange	Button has been pressed and the unit is transmitting. The speed at which the orange LED blinks is directly related to how far down the button is pressed.
3	1 red flash followed by a 2-second pause	Voltage goes below 1.9V during operation – change batteries immediately.
4	2 red flashes followed by a 2-second pause	A push button is active while turning on the transmitter. The button that is active will be designated by the (25, 50, 75, 100) LEDs. See Section 5.4 Push Button Error Table on page 23.
5	3 red flashes followed by a 2-second pause	I-CHIP error.
6	4 red flashes followed by a 2-second pause	Transmitting error, system cannot lock on to the designated channel.
7	Solid green for up to 2 seconds	Transmitter power on with no faults detected (prior to initiating the START function).
8	Solid red	Stop command initiated with receiver E-Stop deactivated.
9	Solid red	Voltage goes below 1.9V at initial power-on – transmitter power shuts off.

5.4 Push Button Error Table

25	50	75	100	Push Button
OFF	OFF	OFF	ON	1
OFF	OFF	ON	OFF	2
OFF	OFF	ON	ON	3
OFF	ON	OFF	OFF	4
OFF	ON	OFF	ON	5
OFF	ON	ON	OFF	6
OFF	ON	ON	ON	7
ON	OFF	OFF	OFF	8
ON	OFF	OFF	ON	9
ON	OFF	ON	OFF	10
ON	OFF	ON	ON	11
ON	ON	OFF	OFF	12

5.5 Troubleshooting Tips

Problems	Possible Reasons	Suggestions
<p style="text-align: center;">No response when transmitter push button is pressed (Improper startup and settings)</p>	Transmitter low battery power	Check the transmitter battery level.
	Emergency stop button activated prior to startup	Prior to turning on the transmitter power switch, make sure that the red emergency stop button is in the raised position.
	Improper startup procedure	Repeat the startup procedure by holding the power key at START position for up to 2.0 seconds and then release.
	Incorrect system RF channel	Make sure that the transmitter handset and the receiver unit both have the same channel.
	Incorrect Receiver Access Code	Make sure that the transmitter handset and receiver unit both have the same Receiver Access Code.
	System out of range	Make sure that the startup procedure is initiated within 100 meters (300 feet) from the receiver location.

6 Declaration of Conformity



MAGNETEK

EU Declaration of Conformity Certificate

For the following equipment:

Product : FlexPro Series Radio Remote Control
Product Receiver Models : CAN-2, MHR, WIC-2402, inteleSmart2, Flex M
Manufacturer's Name : Magnetek, Inc.
Manufacturer's Address : N49 W13650 Campbell Drive
Menomonee Falls, WI 53051 USA

The undersigned hereby declares on behalf of Magnetek, that the above-referenced products, to which this declaration relates, is in conformity with the provisions of CE Mark Directive (93/68/EEC), Machinery Safety Directive (MD) 2006/42/EC, Radio Equipment Directive (RED, 2014/53/EU), EMC Directive (2014/30/EU), and the ROHS2 Directive (2011/65/EU).

The standards relevant for the evaluation of the product referenced above conformity to the directive requirements are as follows:

EN 301 489-1 v1.9.2:2011-09	EN ISO 12100:2010
EN 301 489-17 v2.1.1:2009-05	EN ISO 13849-1:2008
EN 300 220-1 v2.3.1:2010	EN ISO 13849-2:2003
EN 300 220-2 v2.3.1:2010	EN 13557:2003+A2:2008
EN 60204-1:2006	EN 60529:1992
EN 60204-32:2008	

The European contact for Magnetek is:

Brian Preston
Magnetek
Unit 3, Bedford Business Centre
Mile Road
Bedford
MK42 9TW
United Kingdom

Per Annex II.B of the Machinery Directive (2006/42/EC):

The machinery, product, assembly or sub-assembly covered by this Declaration of Conformity must not be put into service until the machinery into which it is to be incorporated has been declared in conformity with the provisions of the applicable Directive(s). This statement is only necessary where the product is to be incorporated into a machine or system (e.g. a safety component).

Signature of Authorized Person:

Travis Tedesco
Engineering Development Manager
Columbus McKinnon Corporation
Bridgeville, PA USA

Date of Issuance: 31 January 2019

Peter Stipan
Director of Development
Columbus McKinnon Corporation
Menomonee Falls, WI USA